

feather&black

Chalfield Bed - Assembly Instructions

Product size: 1150mm H x 2010 mm W x 1433mm D (double)
1150mm H x 2110 mm W x 1583mm D (king)
1150mm H x 2110 mm W x 1893mm D (super king)

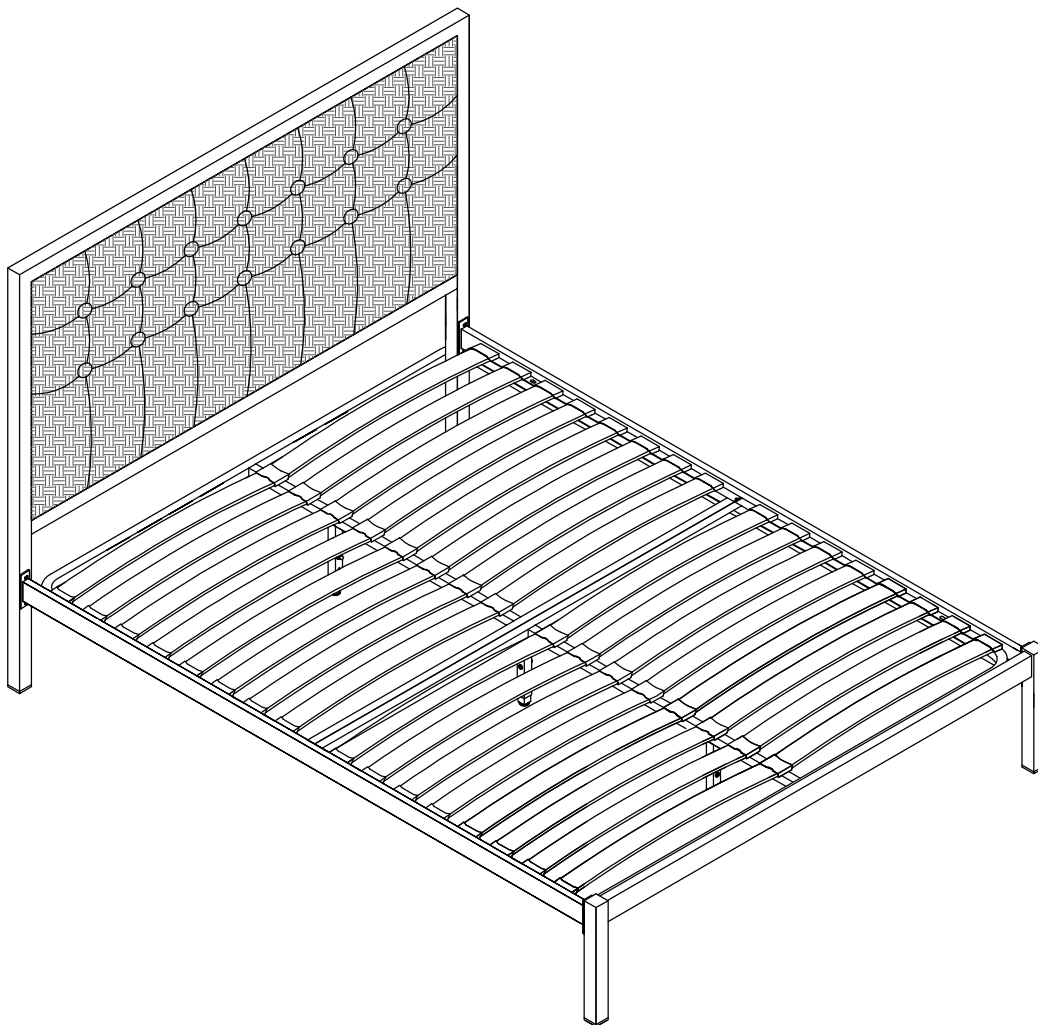

If you require any advice during assembly, please call our customer service team on 01243 380600

Please retain these assembly instructions for future use

Chalfield Bed

Before you start

Thank you for purchasing this chalfield bed.

Please read these instructions fully prior to assembly to familiarise yourself with the various stages of construction. Carefully open all packs supplied and check the contents against the parts and fittings check list.

Do not destroy any of the packaging until you are certain that you have all the necessary parts for the assembly.

This item is heavy once assembled. Please try to assemble the item as close as possible to the point of use. Take care when moving the item to avoid personal injury or damage to the product and always lift rather than drag.

There are small components used in the construction of this furniture as well as plastic packaging, these should be kept away from young children whilst assembling.

Product Safety

All assembly fastenings should always be tightened properly, and care should be taken to ensure that no fittings are loose.

Periodically check and ensure that all components are in their proper position, free from damage, and that all connectors are tight.

Please note depending on the lighting, positioning and surroundings of your room, the shade of the colour can sometimes appear slightly different. Over a period of time the colour might lighten or fade slightly due to light exposure.

Product Care

To clean, slightly moisten cloth with water and wipe surfaces. A damp cloth holds dust and prevents damage. repeat with a dry, soft, lint-free cloth. Do not use abrasives or cleaning products which may contain ammonia or solvents.

Number of people required to assemble

Two person to assemble the product and two people to lift in to position.



Time to assemble



30 min

Necessary tools



Missing parts or faulty products

If you are missing any fixtures or fittings during assembly, or a part is unfortunately faulty please call our customer service team on 01243 380600

feather&black

Chalfield Bed

Components supplied (not actual size)

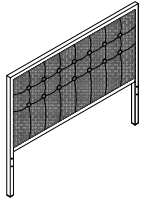

A:Headboard

1433x38x1150mm(double)
1583x38x1150mm(king)
1893x38x1150mm(super king)
1 pcs

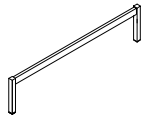

B:Footboard

1433x38x355mm(double)
1583x38x355mm(king)
1893x38x355mm(super king)
1 pcs

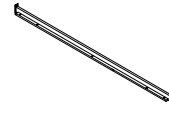

C:Side rails

25x60x1920mm(double)
25x60x2020mm(king)
25x60x2020mm(super king)
2 pcs

Fixtures and fittings supplied (not actual size)

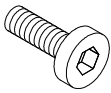

H1:bolt

m6x20mm
8 pcs

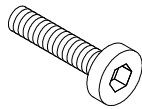

H2:bolt

m6x35mm
4 pcs

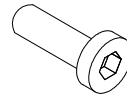

H3: nut

m6x30mm
4 pcs



H4: metal washer

Ø16xØ6x1mm
12 pcs



H5:plastic washer

Ø24xØ8x2mm
8 pcs

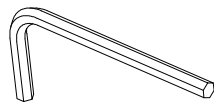

H6: allen key

4mm
2 pcs



0 cm
1
2
3
4
5
6
7
8
9
10
11
12
13
14
15
16
17
18

feather&black

Chalfield Bed

1.

(1) Use bolt (H1), washer (H4) and plastic washer (H5) to fix the side rail (C) on to headboard (A) and footboard (B) by using allen key (H6).

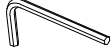
-  H1.m6x20mmx8pcs
-  H4.metal washerx8pcs
-  H5.Plastic washerx8pcs
-  H6.4mm allen key1 pcs

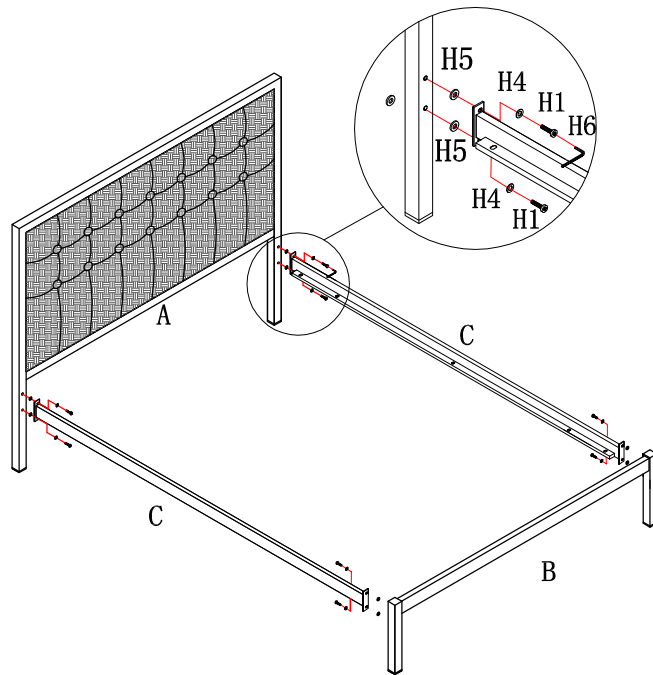

feather&black

Chalfield Bed

2.

(1) Use the bolt (found inside the slat frame box) to fix support leg on to the slat frame.

(2) Carefully locate the slats on to the unit.

(3) Use bolt (H2) and nut (H3) to fix the unit using the allen key (H6).

